

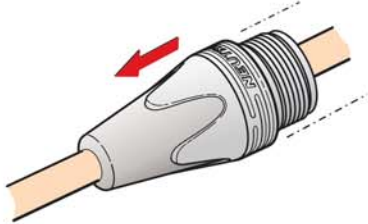

ASSEMBLY INSTRUCTION

NC*FXX & NC*MXX | XLR Cable Connector

A



A Slide the boot onto the cable.

B

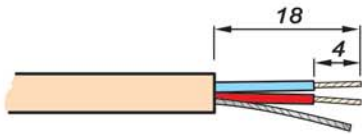

B Prepare cable as shown.

C

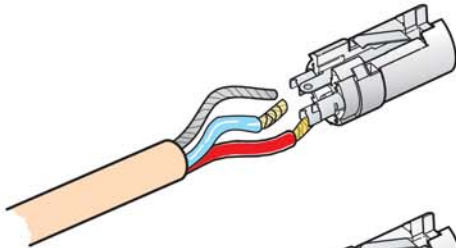

C Insert wires into the terminals and solder them.

D

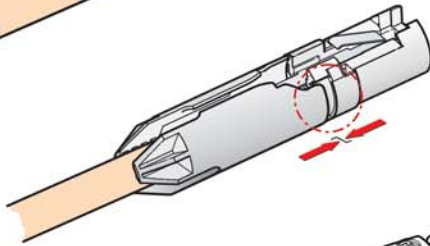

D Put chuck onto the cable.
Attention: Pay attention to the guiding key.

E

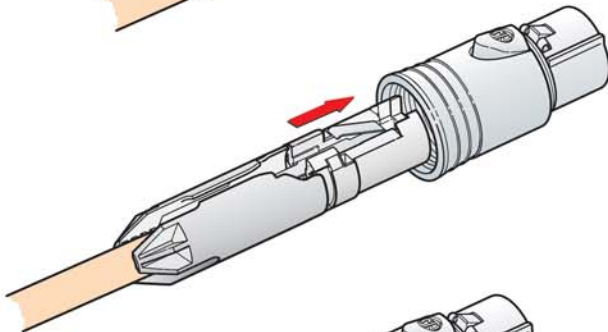

E Slide insert and chuck together into the housing.

F

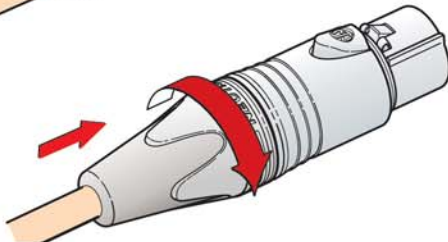

F Finish the installation by turning the bushing onto the connector.

ORDER OF ASSEMBLY

NC*FXX



bushing



chuck



insert

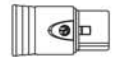

housing

NC*MXX



1723 W. 4th Street Tempe Arizona 85281

P: 800.638.6104 | F: 480.966.6728 | E: sales@covid.com www.covid.com