

HDBaseT Transmitter/Receiver with Audio De-Embedding Set



Receiver Back



Transmitter Back

EHB-220-W

USER MANUAL v1.1



Thank you for purchasing this product

For optimum performance and safety, please read these instructions carefully before connecting, operating or adjusting this product. Please keep this manual for future reference.

Surge protection device recommended

This product contains sensitive electrical components that may be damaged by electrical spikes, surges, electric shock, lightning strikes, etc. Use of surge protection systems is highly recommended in order to protect and extend the life of your equipment.

Table of Contents

Introduction.....	2
Features.....	2
Package Contents	2
Technical Specifications.....	3
Operation Controls and Functions	4-5
EDID Modes.....	6
Preparing RS232 Cable.....	6-7
Firmware Update Process	8-10
RS232 Commands	11
Application Examples.....	12
Connection Diagram	13
Warranty & Safety Information	14

EHB-220-W

Introduction

This HDBaseT Transmitter/Receiver set is used to send an HDMI signal from over 230ft/70m then send to a compatible display. It supports RS-232 pass-through so you can control the source or sync from either side up to 230ft/70m. It also supports audio extraction from the HDMI signal.

Features

- HDMI 2.0, HDCP 1.4 & 2.2
- Video resolutions up to 4K2K@60Hz
- Audio up to 7.1 channels of High Definition audio pass through (LPCM, Dolby TrueHD, and DTS-HD Master Audio).
- Supports HDMI High Bit Rate (HBR) audio pass through
- Extract audio supports LPCM 2CH
- POC (Power Over Cable) functionality is supported, either TX or RX is powered by a 24V@1A power supply. POC Power consumption is less than 10W.

See application example 1 (see page 12)

- Transfer Bidirectional RS-232 control signal together with the HDMI signal.

See application example 2 (see page 12)

- Transmission distance: Over CAT6 cable
70 meters: 1080P @60Hz; 3D1080P@30Hz
40 meters: 1080P @60Hz; 1080P @120Hz; 3D1080P@60Hz; 4K x 2K@60Hz

Package Contents

- HDMI Extender Receiver - 1PC
- HDMI Decora Transmitter - 1PC
- 24V1A DC Power Supply - 1PC
- Mounting Brackets - 2PCS
- 3.5mm Audio Cable - 1PC
- 3pin Screw Terminal Plug - 1PC
- Operation Manual - 1PC



EHB-220-W

Technical Specifications

Technical	
HDMI Compliance	HDMI 1.4b & HDMI 2.0
HDCP Compliance	HDCP 2.2 and HDCP 1.4
Video Bandwidth	[18Gbps]
Video Resolutions	up to,4K2K@60Hz,1080P@120Hz, and 1080P 3D@60Hz
Color Space	RGB, YCbCr 4:4:4, YCbCr 4:2:2
Color Depth	8-bit, 10-bit & 12-bit
HDMI Audio Formats (Pass-through)	LPCM 2/5.1/7.1CH, Dolby Digital, DTS 5.1, Dolby Digital+, Dolby TrueHD, DTS-HD Master Audio, Dolby Atmos, DTS:X
Extract Audio Formats	LPCM 2CH
ESD Protection	Human body model - +/- 8kV (air-gap discharge) & +/-4kV (contact discharge)

Connections - Transmitter	
Inputs	1x HDMI Type A [19-pin female] 1x 24V DC Power In
Outputs	1x HDBaseT Out [RJ45] 1x RS232 [Screw Terminal] 1X IR 1X 5V

Connections - Receiver	
Inputs	1xDC Power In 1x HDBaseT In [RJ45] 1x RS232 [Screw Terminal]
Outputs	1x HDMI Type A [19-pin female] 1x Audio OUTPUT [3.5mm Stereo Mini-jack]

Mechanical	
Housing	Metal Enclosure
Color	Black
Dimensions	65mm [W] x 115mm [D] x 17mm [H]
Weight	200g
Power Supply	Input: AC100 - 240V 50/60Hz Output: DC 24V/1A (US/EU standards, CE/FCC/UL certified)
Power Consumption	6W (Max)
Operation Temperature	32 - 104 °F / 0 - 40 °C
Storage Temperature	-4 - 140°F / -20 - 60°C
Relative Humidity	20 - 90% RH (no condensation)

EHB-220-W

Operation Controls and Functions

5.1 Receiver Front and Rear Panel

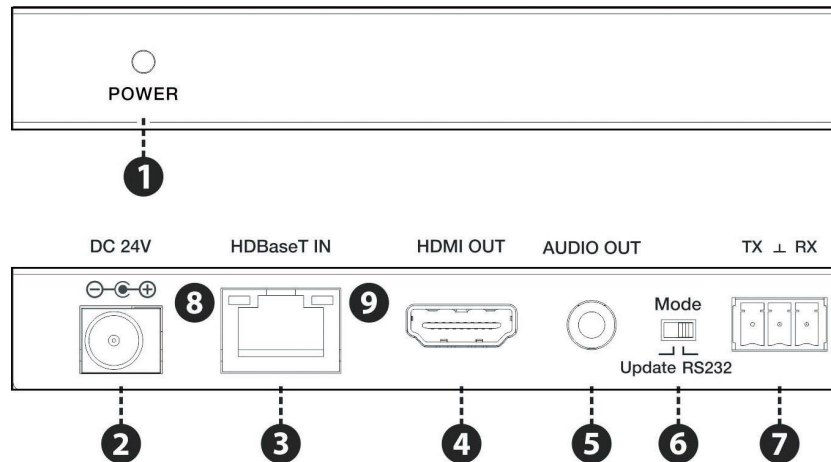

1. **Power LED:** System power indicator.
2. **DC 24V:** Connect 24V/1A adapter to AC wall outlet for power supply.
3. **HDBaseT In:** HDBaseT signal input port. Connect HDBaseT transmitter with a category cable.
4. **HDMI Out:** HDMI output port.
5. **Audio Out:** Analog audio output from HDMI signal.
6. **Mode:** The Update Mode and the RS-232 mode selector.
 - **Update Mode:** When the dial switch is set to update, port 7 is used to update or control the device.
 - **RS-232 Mode:** When the dial switch is set to RS232, port 7 is used for RS232 pass-thru communication.
7. **RS-232:** RS232 communication port that passes through from transmitter to receiver and receiver to transmitter.
8. **Connection Signal Indicator Lamp**
 - **On (Solid):** The Transmitter and Receiver are communicating.
 - **Flashing:** The Transmitter and Receiver are not communicating properly.
 - **Off:** The Transmitter and Receiver are not connected by a category cable.
9. **Data Signal Indicator Lamp**
 - **On (Solid)** The HDMI signal is carrying HDCP.
 - **Flashing:** The HDMI signal is not carrying HDCP.
 - **Off:** No HDMI signal.

EHB-220-W

5.2 Transmitter Front and Rear Panels

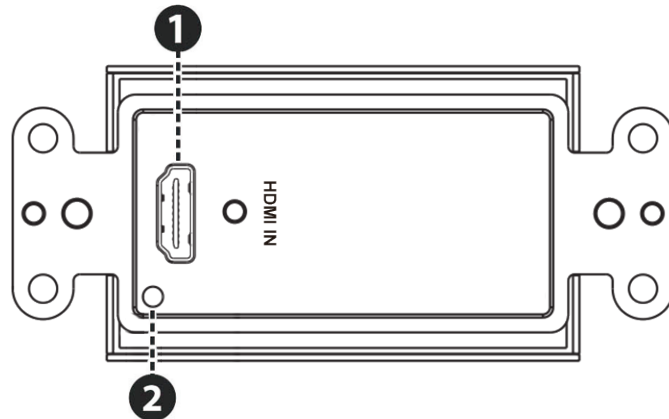

1. **HDMI In:** Connect to HDMI source devices.
2. **Active:** Green LED input signal indicator.

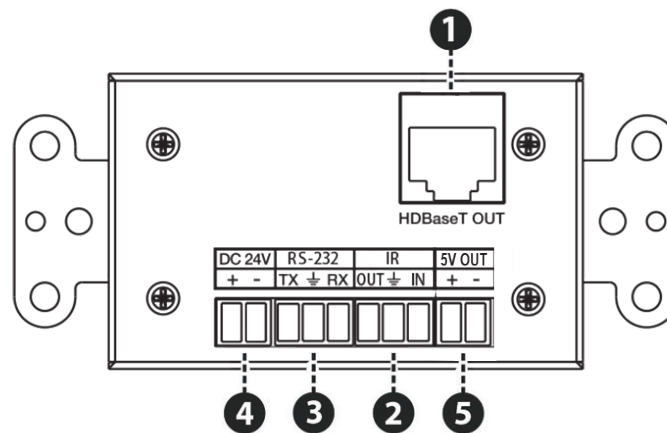

1. **HDBaseT OUT:** HDBaseT output port. Connect to HDBaseT receiver with a category cable.
2. **IR IN/OUT:** Use the phoenix jack to connect IR input or output.
3. **RS-232:** Use the phoenix jack to connect PC or control system to transmit RS-232 commands.
4. **DC 24V:** Use the phoenix jack to connect power supply.
5. **5V Out:** 5 Volt power for use with IR

EHB-220-W

EDID MODES

The RBH-220 can use an internal EDID from memory instead of the EDID provided by the display. Capturing the EDID from the display is the default mode of operation of the RBH-220. This EDID will change based on what display device is connected to the RBH-220. The internal EDID has been pre-loaded in case there is a compatibility issue with the display EDID for the connected sources. To change the EDID mode, flip the mode switch on the back of the device to update mode and send the command for setting the EDID mode from the RS232 command table. Default system EDID support 1080P.

Preparing RS232 Cable

What you will need:

- A two-conductor cable with ground terminated with DB9 connectors or not
- Wire strippers
- Screwdriver (flat head)
- 3.5mm captive screw connector with 3 positions (included with plate)
- Heat gun and heat shrink (optional)
- Multimeter (optional)

Depending on your setup, you will need an RS232 cable with terminal block on one end to connect to the unit and either another terminal block or DB9 on the other side. The focus of this section will be on terminating the terminal block side with the proper pinout because that is what is connected to the unit. The other end of the cable is dependent on what the unit is connecting too, but all the information in this section will help to get the proper pinout in any case. As a tip, if connecting to a computer without a serial port, a USB to serial port converter can be used to communicate with RS232.

If the cable is terminated on both sides, start by cutting off the end that will be used for connecting to the unit. Then, strip the outer jacket of the cable back by about 1 inch like what is shown in Step 1 below. Once the outer jacket is removed, you can optionally add heat shrink around the conductors and over the exposed drain wire like in the picture of step 2. Next, strip the ends of the conductors back about 3/16" in order to make good contact inside of the captive screw connector. The final step is to attach the captive screw connector to the end of the cable matching the conductors on the other side of the cable to what is shown in step 3, use the connectors shown in the following figure as a reference if using DB9 male or female. Test the conductors with a multimeter to confirm termination.

EHB-220-W

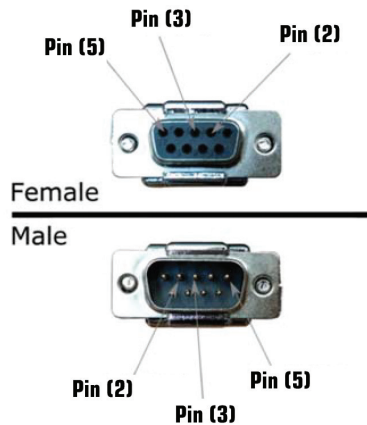
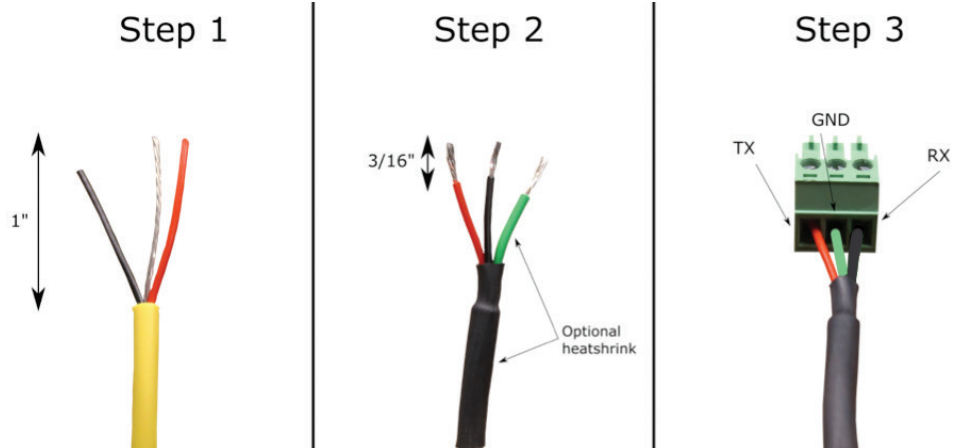

NOTE:

When using the device for pass-through, keep in mind that the side (either Tx or RX) that is connected to the device that the commands are getting sent to will require that the Tx and Rx pins get swapped around (serial null modem wiring). This means pin 2 of the DB9 connector will connect to the Rx pin of the HDBaseT device and pin 3 of the DB9 connector will connect to the Tx pin of the HDBaseT device.

Firmware Update Process

1. First power down the unit and remove all the cables from the IO port.
2. Connect the Rs232 port and slide the **“Mode” switch to “Update” position**

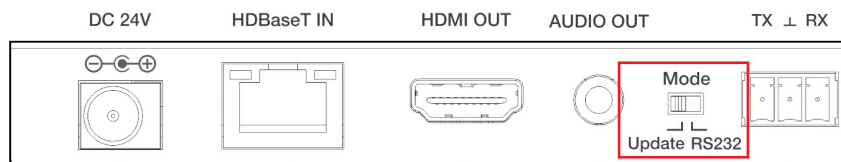

3. Open up COMSIP firmware update program

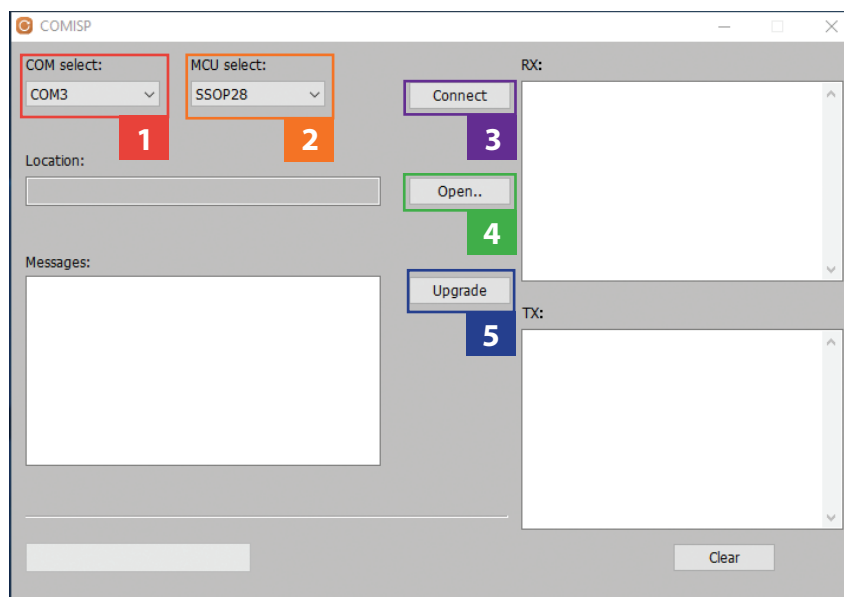

4. Follow the sequence below on the upgrade program

- 1** Select the COM port,
- 2** Select MCU as SSOP28
- 3** Click the Connect tab.
- 4** Click the Open tab to select the FW file for update.
- 5** Click the Upgrade tab. The unit will begin sending 80 00 00 sequence in the TX:

EHB-220-W

RS232 Commands

Action	Basic ASCII String	Variables
Setting the EDID mode	>edid:a<cr><lf>	a = EDID mode (ext = external int = internal)
Query EDID mode	?edid<cr><lf>	
Query firmware	?fw<cr><lf>	
> - Command, ? - Query		
<cr> = 0x0D Hex / 13 Decimal		
Note: The default communication settings are 9600 8N1 None.		

Application Example 1

POC (Power Over Cable)

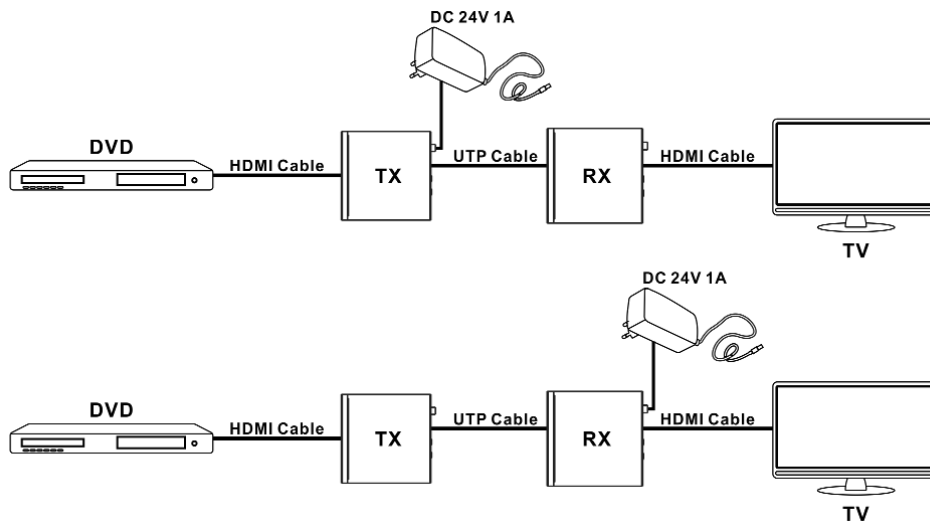

Application Example 2

Bidirectional RS232 Control

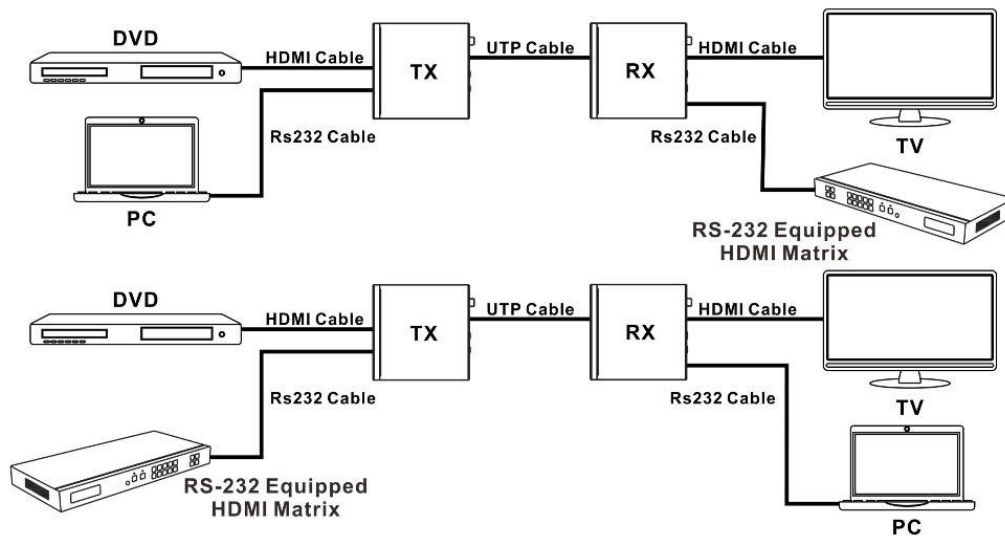

EHB-220-W

USER MANUAL v1.1



Connection Diagram 4K@60Hz

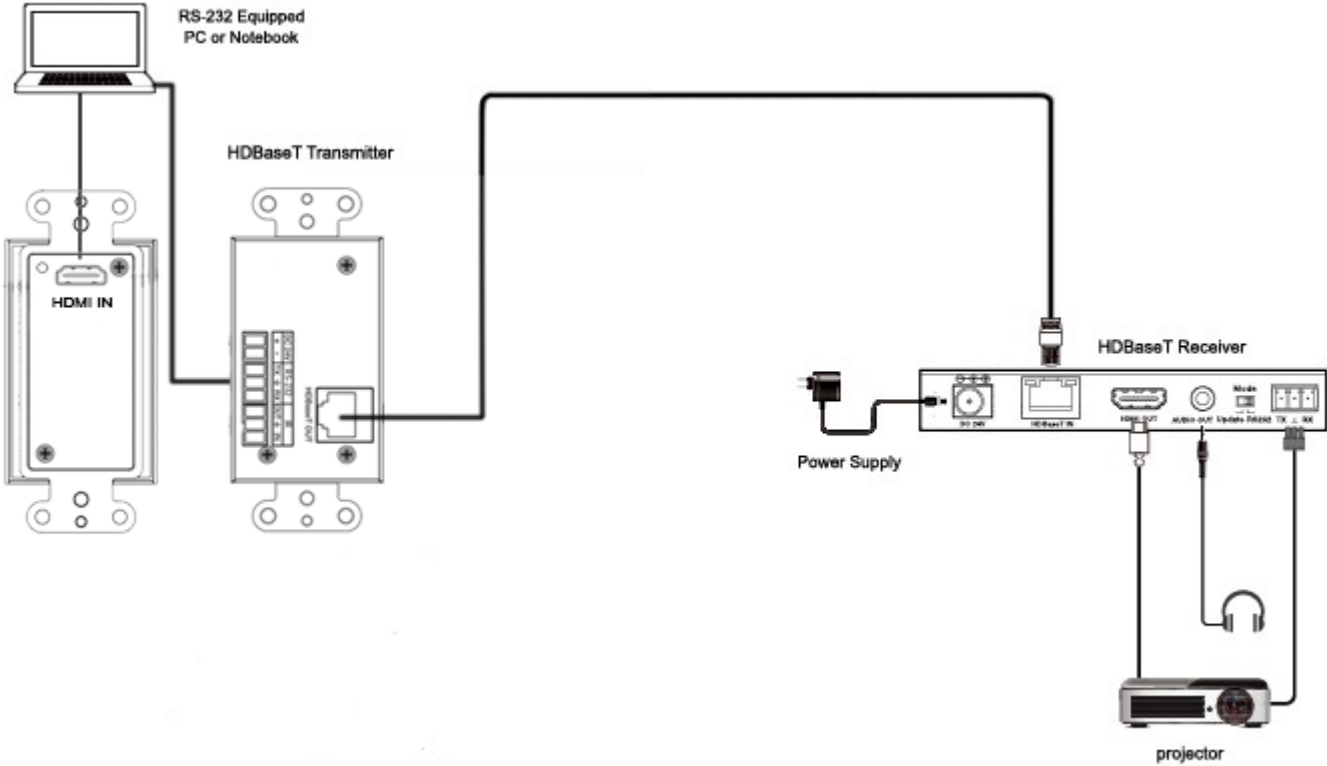

EHB-220-W

Warranty

Parts and labor warranty time is three year and from the date of original shipment. This warranty shall be void if a serial number has been removed from the product.

Upon determination of a legitimate defect covered by this warranty and at COVID's sole discretion, user should bear the transport cost during the warranty.

If product is out of warranty then repair charge is required. Out of warranty repairs will only be made after cost has been approved by Customers and proper financial arrangements are made. Customer must cover round trip shipment expenses.

Safety Information



To reduce the risk of electric shock, do not expose this product to rain or moisture.



Do not modify the wall plug. Doing so will void the warranty and safety features.



If the wall plug does not fit into your local power socket, hire an electrician to replace your obsolete socket.



This equipment should be installed near the socket outlet and the device should be easily accessible in the case it requires disconnection.

EHB-220-W