

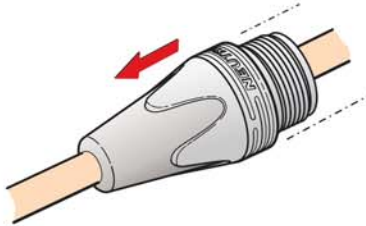

# ASSEMBLY INSTRUCTION

## NC\*FXX & NC\*MXX | XLR Cable Connector

Ⓐ



Ⓐ Slide the boot onto the cable.

Ⓑ

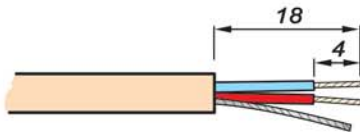

Ⓑ Prepare cable as shown.

Ⓒ

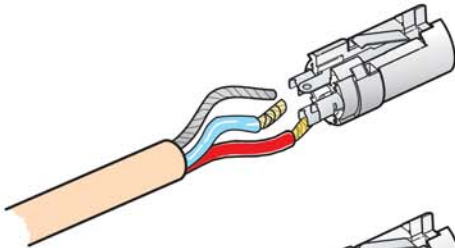

Ⓒ Insert wires into the terminals and solder them.

Ⓓ

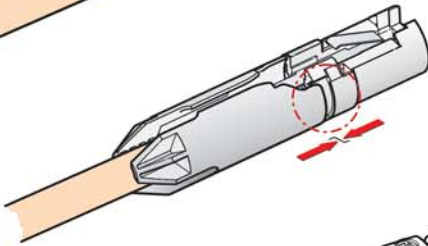

Ⓓ Put chuck onto the cable.  
**Attention: Pay attention to the guiding key.**

Ⓔ

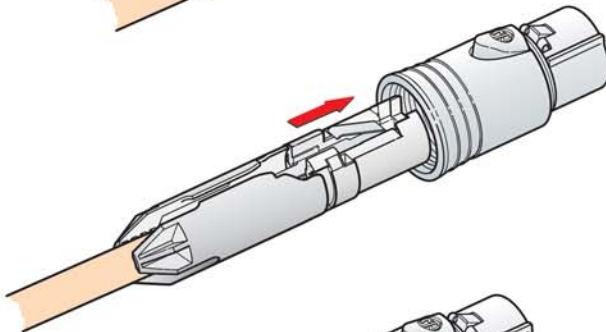

Ⓔ Slide insert and chuck together into the housing.

Ⓕ

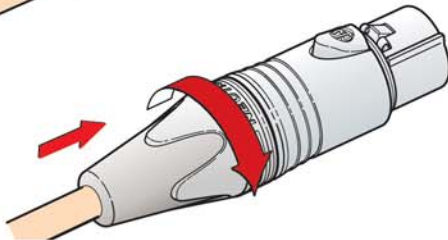

Ⓕ Finish the installation by turning the bushing onto the connector.

### ORDER OF ASSEMBLY

#### NC\*FXX



bushing



chuck



insert

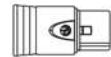

housing

#### NC\*MXX



1723 W. 4th Street Tempe Arizona 85281

P: 800.638.6104 | F: 480.966.6728 | E: sales@covid.com www.covid.com